

WAVELINE®

10'w x 3'h WL Hanging Sign

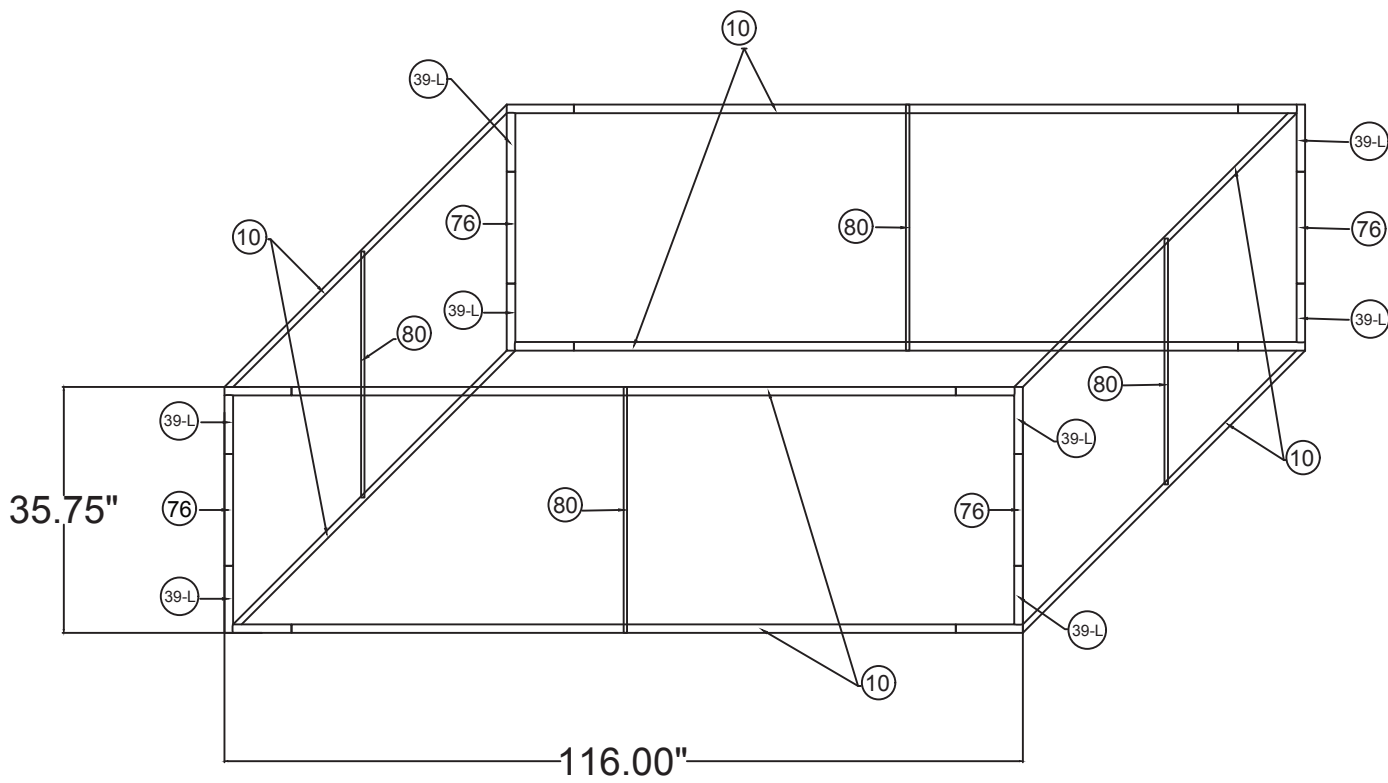

SHS1036

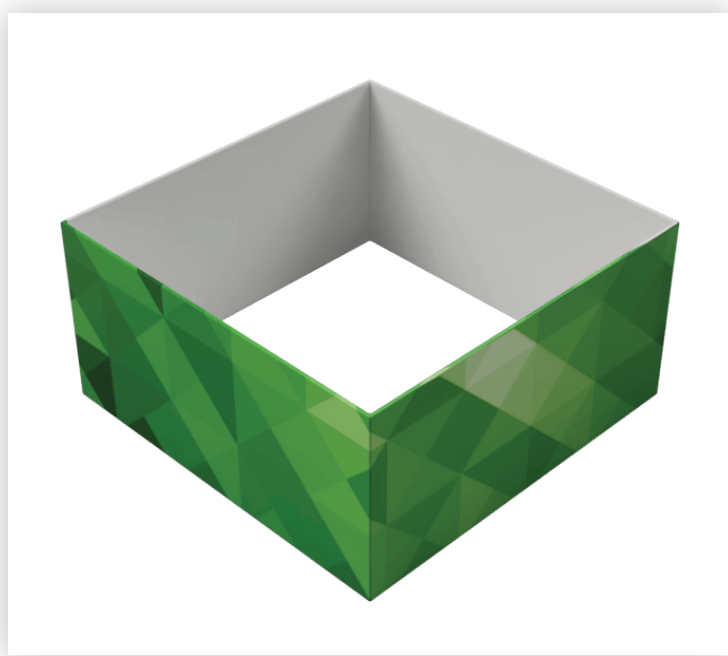

10'w x 3'h WL Hanging Sign	
Qty.	Part Number
8	WLM#039L-US
4	WLM#076
4	WLM#080
8	WLM#010
1	BGO-FABRIC-L bag

Notes:

- * Does not include Hanging Cables
- * Will fit inside a CA600 or CA900 case

