

# WAVELINE®

## 10'w x 6'h WL Hanging Sign

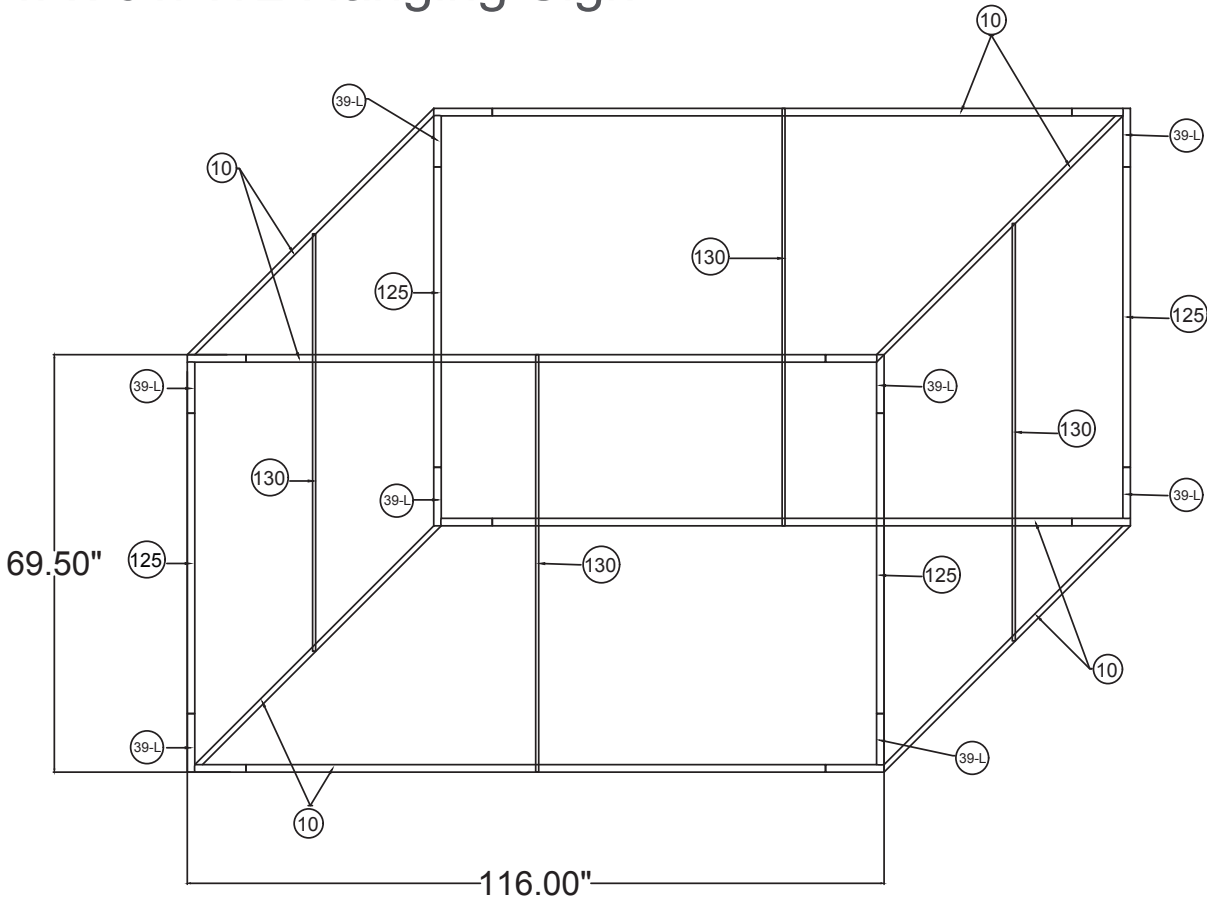

### SHS1072

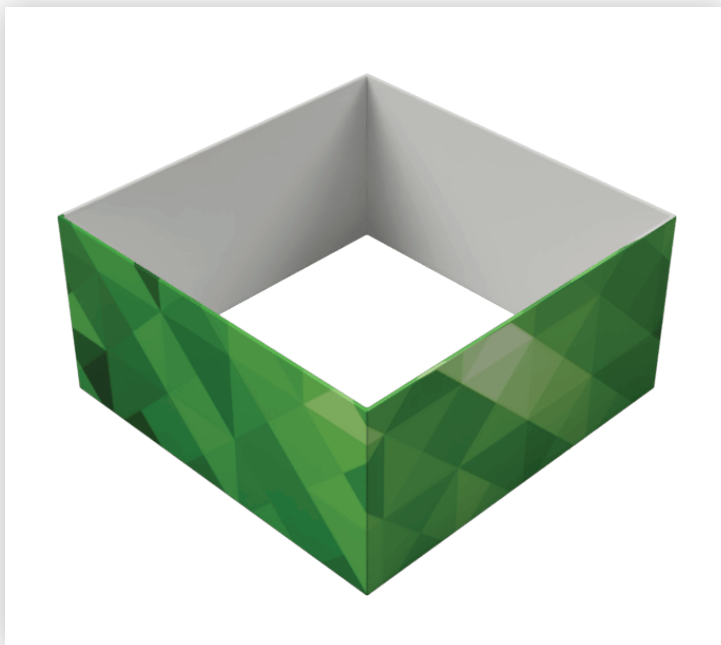

10'w x 6'h WL Hanging Sign	
Qty.	Part Number
8	WLM#039L-US
8	WLM#010
4	WLM#125
4	WLM#130
1	BGO-FABRIC-L bag

**Notes:**

- \* Does not include Hanging Cables
- \* Will fit inside a CA600 or CA900 case

# WAVELINE®

## Hanging Sign Rigging Instructions



### Step 1

After assembling the sign, locate the hanging points. There are openings on the zipper to allow for cables to be inserted



### Step 2

Open the zippers to expose the hanging area, then wrap the cables around the vertical support pole

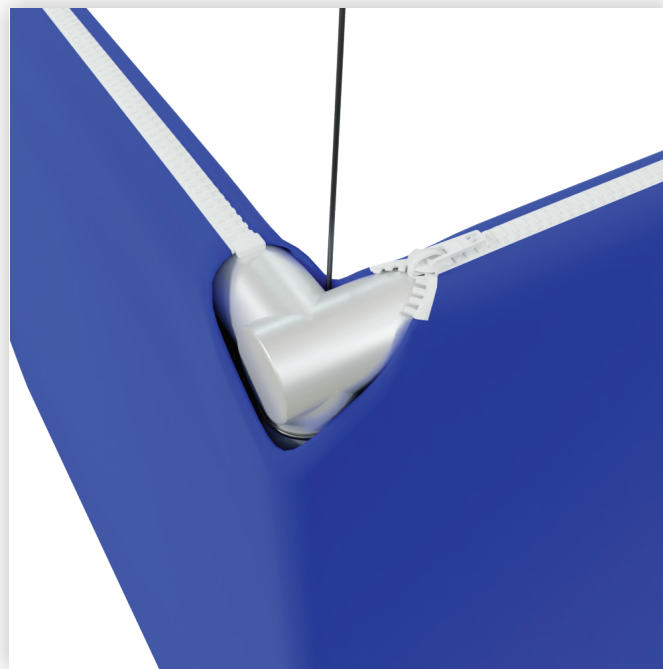

### Step 3

Pull the cable through the opening in the fabric. Close the zippers.

\*Hanging cables are not included in the kit, to be provided by on-site rigging team.